

Cable-Extension Position Transducer

Incremental Encoder Output
Ranges: 0-50 to 0-250 inches
Industrial Grade • High Cycle Applications



PT5E

Specification Summary:

GENERAL

Full Stroke Range Options 0-50 to 0-250 inches
 Output Signal Options incremental encoder (quadrature)
 Accuracy *see ordering information*
 Repeatability *see ordering information*
 Resolution 10 to 250 pulses per inch
 Measuring Cable Options stainless steel or thermoplastic
 Enclosure Material hard anodized aluminum
 Sensor optical encoder
 Maximum Measuring Cable Velocity *see ordering information*
 Maximum Retraction Acceleration *see ordering information*
 Weight 5 lbs. max.

ELECTRICAL

Input Voltage *see ordering information*
 Input Current *see ordering information*

ENVIRONMENTAL

Enclosure NEMA 4/6, IP 65/67
 Operating Temperature 0° to 160°F (-17° to 71°C)
 Vibration up to 10 G's to 2000 Hz maximum



The PT5E encoder-based cable-extension transducer offers a unique thermoplastic cable that has virtually an infinite fatigue life. This cable, known as V62, has properties that are superior for high cycle and rugged applications.

Like Celesco's other transducers, the PT5E installs in minutes, functions properly without perfectly parallel alignment, and fits easily into small areas. The PT5E offers additional installation flexibility since its cable exit can be rotated relative to the mounting surface, providing four different cable exit orientations.

Outline Drawing

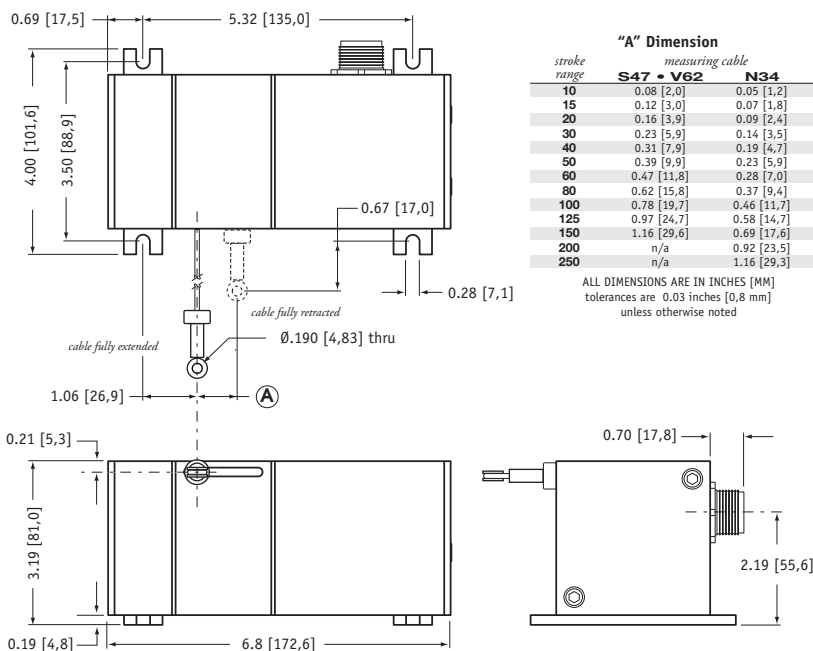

Output Signal

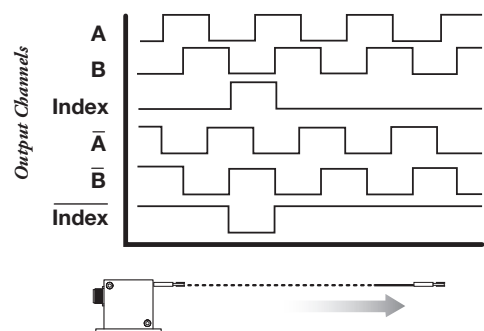

Ordering Information:

Model Number:

PT5E - - - - - -
order code: **R** **A** **B** **G** **D** **E**

Sample Model Number:

PT5E - 100 - N34 - FR - 100 - AB-TTL - M6

- R** range: 100 inches
- A** measuring cable: .034 nylon-coated stainless steel
- B** cable exit: front
- G** resolution: 100±2 pulses per inch
- D** output signal: TTL/CMOS compatible driver
- E** electrical connection: 6-pin plastic connector

Full Stroke Range:

R <i>order code:</i>	50	100	150	200	250	1250	2500	3750	5000	6250
full stroke range, min:	50 in.	100 in.	150 in.	200 in.	250 in.	1250 mm	2500 mm	3750 mm	5000 mm	6250 mm
Δ accuracy (\pm % of f.s.):	.1	.07	.06	.05	.04	.1	.07	.06	.05	.04
repeatability (\pm % of f.s.):	.02	.01	.01	.01	.01	.02	.01	.01	.01	.01
cable tension (\pm 20%):	41 ounces			21 ounces		11,4 N		5,8 N		
max. cable velocity • acceleration:	300 in./sec • 5 G's			120 in./sec • 2 G's		8 M/sec • 5 G's		3 M/sec • 2 G's		

Measuring Cable:

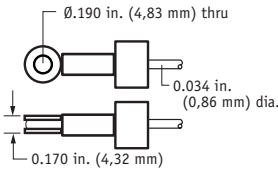
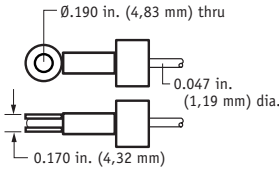
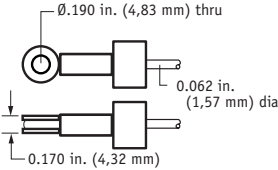
A <i>order code:</i>	N34	S47	V62
	.034 nylon-coated stainless steel <i>available in all ranges</i>	.047 stainless steel <i>all ranges up to 150 inches</i>	.062 thermoplastic <i>all ranges up to 150 inches</i>
			

Cable Exit:

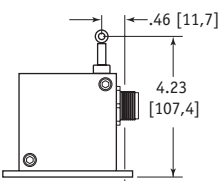
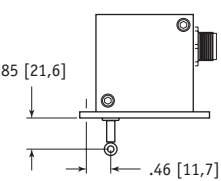
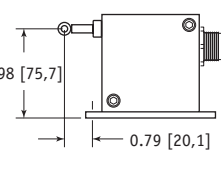
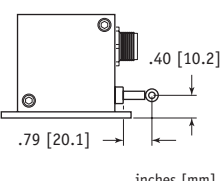
B <i>order code:</i>	UP	DN	FR	BK
	up	down	front	back
				
	inches [mm]			

Resolution:

G <i>order code:</i>	10	100	200	250
resolution for english ranges:	10 \pm 0.2 pulses per inch	100 \pm 2 pulses per inch	200 \pm 4 pulses per inch	250 \pm 5 pulses per inch
G <i>order code:</i>	.5	5	10	12.5
resolution for metric ranges:	0.5 \pm 0.01 pulses per mm	5 \pm 0.1 pulses per mm	10 \pm 0.2 pulses per mm	12.5 \pm 0.3 pulses per mm

Ordering Information (cont.)

Output Signals:

① order code:	AB-TTL	AB-OC	ABC-LD	ABC-UD	ABZC-UD
output driver:	TTL/CMOS compatible	open collector	5-volt line driver	universal line driver <i>(no index)</i>	universal line driver <i>(with index)</i>
input voltage:	4.5...13.2 VDC	10.8...26.4 VDC	5 VDC	5...30 VDC	5...30 VDC
max. source/sink current:	20 mA sink	20 mA sink	20 mA sink	20 mA source/sink	20 mA source/sink
max. input current:	80 mA	80 mA	150 mA	100 mA, no load	100 mA, no load

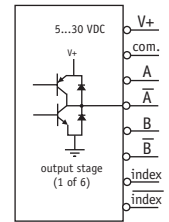
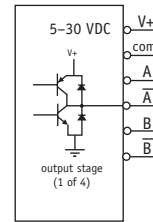
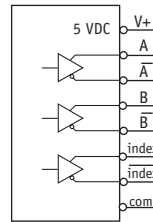
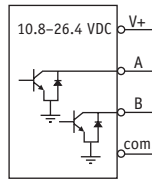
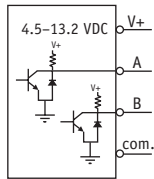

Electrical Connection:

② order code:	MC4	M6	M6M	M18	C25
	4-pin micro-connector with 12 ft [3.5 M] cord set IP 67, NEMA 6	6-pin plastic connector with mating plug IP 67, NEMA 6	6-pin metal connector with mating plug IP 65, NEMA 4	18-pin plastic connector with mating plug IP 67, NEMA 6	25-ft. instrumentation cable 24 AWG, shielded IP 67, NEMA 6

4-pin cordset:



pin	color code	TTL/CMOS Open Collector input voltage	5 V Line Driver Universal Line Driver input voltage
1	RED-BLK TR.	channel A	channel A
2	RED-WHT TR.	channel B	channel B
3	RED	common	common
4	GREEN	common	common

6-pin mating plug:

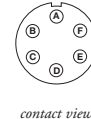

pin	TTL/CMOS Open Collector input voltage	5 V Line Driver Universal Line Driver input voltage
A	channel A	channel A
B	channel B	channel B
C	common	channel A'
D	channel B	channel B'
E	-	channel A'
F	-	channel B'

18-pin mating plug:

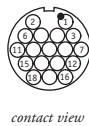

pin	TTL/CMOS Open Collector input voltage	5 V Line Driver Universal Line Driver input voltage
1	channel B	channel B
2	channel A	channel A
3	common	common
6	channel A	channel A
7	-	index
11	-	channel B'
12	-	channel A'
15	-	index'

25-ft. instrumentation cable:

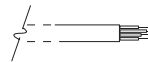

color	TTL/CMOS Open Collector input voltage	5 V Line Driver Universal Line Driver input voltage
red	channel B	channel B
black	channel A	channel A
green	channel B	channel B
white	common	common
blue	-	channel A'
brown	-	channel B'
yellow	-	index
orange	-	index'

北京赛斯维测控技术有限公司
 北京市朝阳区望京西路48号
 金隅国际C座1002
 电话: +86 010 8477 5646
 传真: +86 010 5894 9029
 邮箱: sales@sensorway.cn
<http://www.sensorway.cn>

① Total accuracy includes uncertainty due to resolution and is calculated: $\pm \{[(\%FS)(FS) + \text{length of 1 pulse}]\}$

Example: Model Number: PT5E-100-N34-FR100-AB-TTL-M6

Full Stroke: 100 inches

Accuracy: $[.07\% (100 \text{ in.}) + 1/100 \text{ in.}] = \pm .08 \text{ inches}$

version: 5.0 last updated: December 26, 2007